



www.klauke.com

ESG 25CFM



Serialnumber

HE.16842_G © 05/2016 R&D-2



Gustav Klauke GmbH • Auf dem Knapp 46 • D-42855 Remscheid • Telefon ++49 +2191-907-0 • Telefax ++49 +2191-907-141 • www.klauke.com

Klauke[®]

EMERSON

Wir freuen uns, dass Sie sich für ein Klauke Werkzeug entschieden haben und wünschen Ihnen viel Freude damit.

2 Jahre Garantie Sie haben ein Qualitätsprodukt „Made in Germany“ erworben und erhalten 2 Jahre Garantie. Diese beginnt mit dem Kaufbelegdatum.

Um lange Freude und eine einwandfreie Funktion des Werkzeuges sicherzustellen, muss das Gerät spätestens beim Erreichen von 10.000 Arbeitsvorgängen oder nach 3 Jahren durch ein Autorisiertes Service Center (ASC) gewartet werden. Wird das Wartungsintervall von 10.000 Arbeitsvorgängen nicht eingehalten, erlischt der Garantieanspruch.

Im Rahmen dieser Wartung werden verschlissene Teile ersetzt und sicherheitsrelevante Teile geprüft und ggf. vorbeugend ersetzt.

Darüber hinaus empfehlen wir das Gerät jährlich zur Überprüfung an das zuständige ASC einzusenden.

Für Fragen rund um unseren Werkzeugservice oder eine Frage zu einem bestimmten Anwendungsfall stehen wir Ihnen persönlich unter der kostenlosen 0800-4685528 zur Verfügung.



Ihr Klauke Team

Thank you for choosing a Klauke tool. We hope it gives you lots of pleasure.

2 years Warranty You have purchased a quality product „Made in Germany“, which is covered by a 2 year warranty. The warranty commences from the purchase receipt date.

To ensure lasting enjoyment and a flawless tool function, the product must be serviced by an Authorized Service Center (ASC) after 10,000 operations or after 3 years. Should the service Interval exceed 10.000 cycles the warranty claim is void.

The Service includes predictive maintenance in which worn-out parts will be replaced and safety relevant parts checked/replaced.

We recommend to have the tools checked yearly through an Authorized Service Center (ASC).

If you have any questions about our tool service or about a specific application, please go to <http://www.klauke.com/en/support/tool-service/>



Your Klauke team



ESG 25CFM

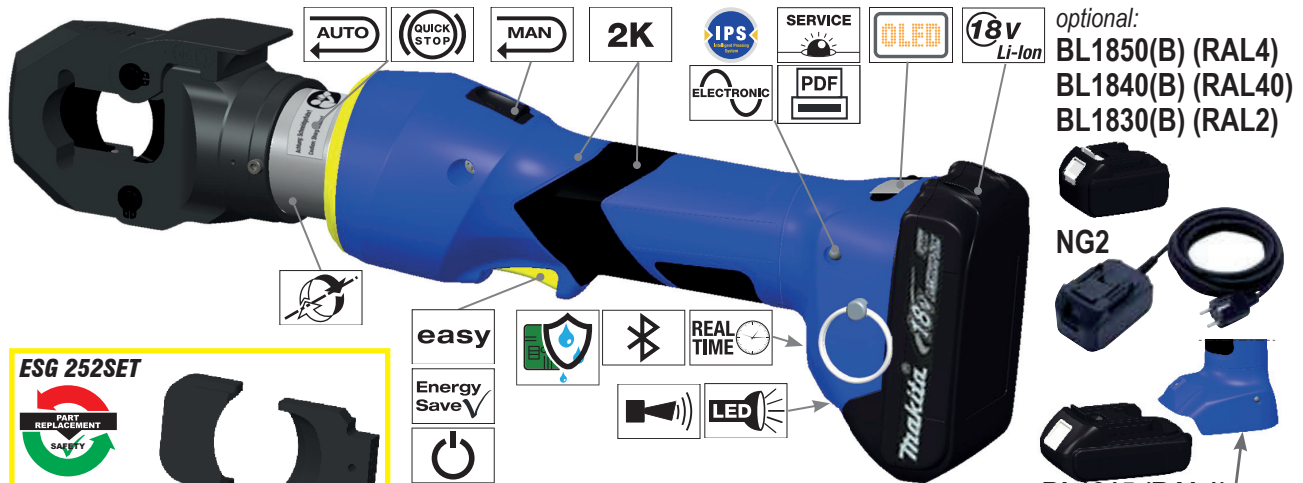

optional:
 BL1850(B) (RAL4)
 BL1840(B) (RAL40)
 BL1830(B) (RAL2)



ESG 252SET

Intended use/
 Forseeable misuse
 see page IV
 replacement
 see page IX - XII

ESG 252FSSET

Intended use/
 Forseeable misuse
 see page V
 replacement
 see page IX - XII

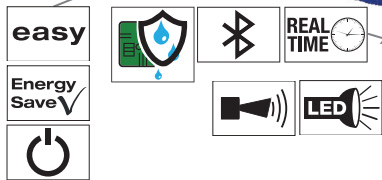

2 years Warranty
 World wide Tool Service

ACHTUNG! Be Beschädigung des Garantiesiegels
ATTENTION! Warranty seal if broken loses Warranty

datecode

Year	Code	Month	Code	Month	Code
2018	M	Jan.	N	July	V
2019	N	Feb.	P	Aug.	W
2020	P	Mar.	Q	Sept.	X
2021	Q	Apr.	R	Oct.	Y
2022	R	May	S	Nov.	Z
2023	S	June	T	Dec.	1

For US and Canada only

FCC ID: RFRMS42 • IC: 4857A-M842
 Model: CFM

This device complies with Part 15 of the FCC Rules and with Industry Canada licence-exempt RSS standard(s). Operation is subject to the following two conditions: (1) this device may not cause harmful interference, and (2) this device must accept any interference received, including interference that may cause undesired operation.

HE18055_D

batch# e.g. 304711
 datecode e.g. P = 2020; R = April
 consecutive# e.g. „142“ = tool # 142

304711
 PR
 142

Klauke
 Auf dem Knapp 46
 D-42855
 Remscheid





ESG 25CFM

Klauke®

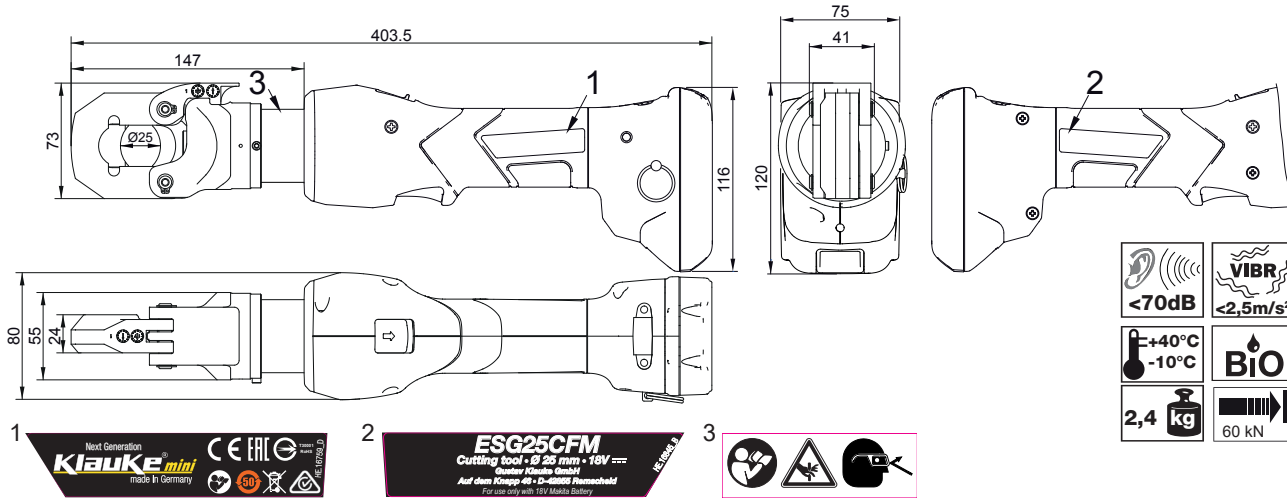

! WARNING

Read all safety warnings, instructions, illustrations and specifications provided with this power tool.

Failure to follow all instructions listed below may result in electric shock, fire and/or serious injury.

Save all warnings and instructions for future reference.





ESG 25CFM

Klauke®

Use tool only with 18V Makita Battery



- BL1850(B) 45 min. RAL4
 - BL1840(B) 36 min. RAL40
 - BL1830(B) 22 min. RAL2
 - BL1815 15 min. RAL1
- 10 - 40°C

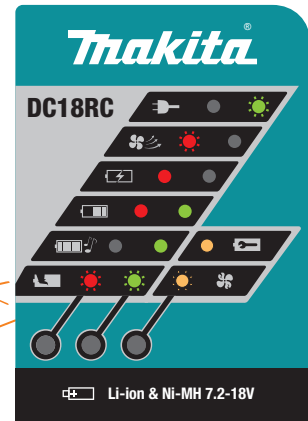

Alle Bedienungsanleitungen auch unter www.klauke.de abrufbar
All manuals are also available on www.klauke.com











IEC
60228



CL1&2



Bestimmungsgemäße Verwendung Intended use

 Eindrähtiger Rundleiter cable CL1 - re	 Mehrdrähtiger Rundleiter cable CL2 - rm	 Verdichtet Mehrdrähtig cable CL2 - rmV compacted	
 Freileitung (Aldrey) conductor CL2 - rm	 ACSR	 Armierter Leiter reinforced conductor	

Vorhersehbare Fehlanwendung Foreseeable misuse

  Feindrähtig cable CL5 - F	 Feinstdrähtig cable CL6 - F		





ESG 252FSSET

replacement
see page IX - XII

SW2,5

IEC
60228

CL1&2

Ø25mm

**Bestimmungsgemäße Verwendung
Intended use**

Feindrähtig cable CL5 - F	Feindrähtig Stahlseile steel cables	Mehrdrähtiger Rundleiter cable CL2 - rm	Verdichtet Mehrdrähtig cable CL2 - rmV compacted

**Vorhersehbare Fehlanwendung
Foreseeable misuse**

Feinstdrähtig cable CL6 - F	Eindrähtiger Rundleiter cable CL1 - re		
Freileitung (Aldrey) conductor CL2 - rm	ACSR	Armierter Leiter reinforced conductor	





ESG 25CFM

Klauke®

⚠️ ⚡ > 350° STOP

Klauke ASC
Authorised Service Center

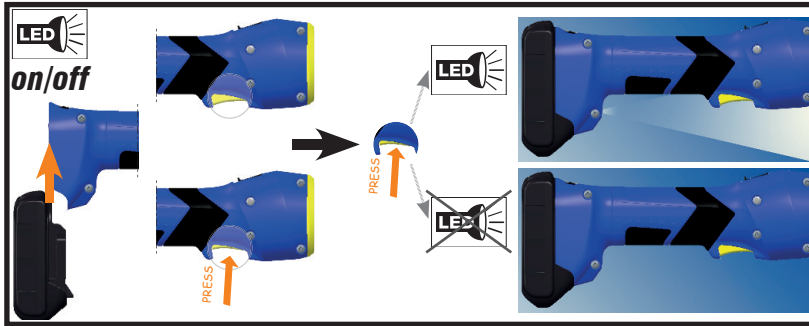
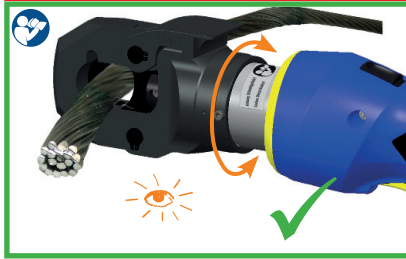



ESG 25CFM

Klauke®

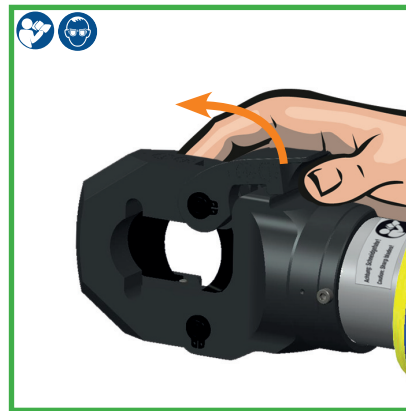
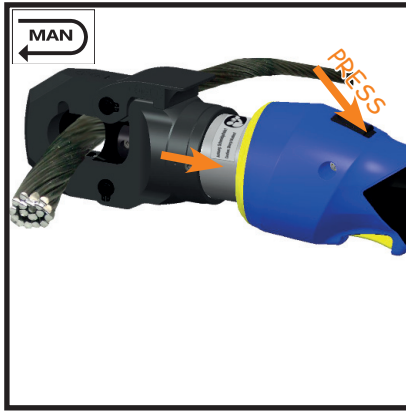



ESG 25CFM

Klauke®

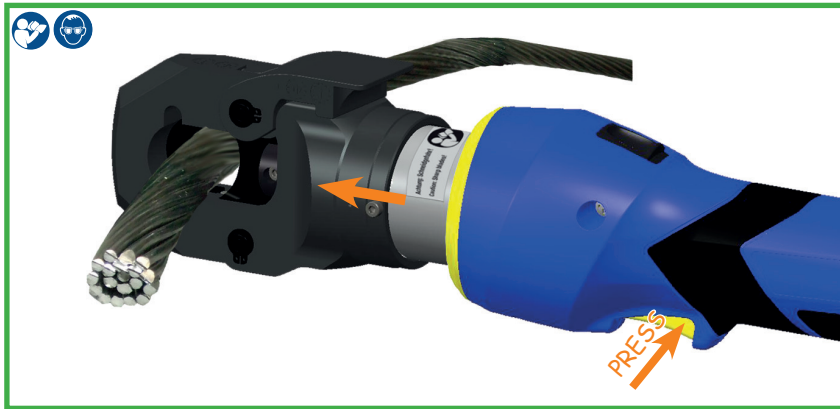



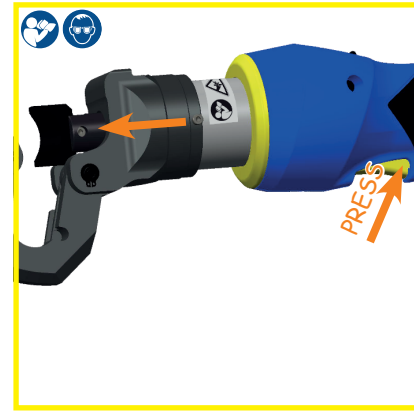



ESG 25CFM

Klauke®





ESG 25CFM

Klauke®





1			ERROR CODE: ****	Error code *1
2		BT	P 3 bar P 3 bar	Bluetooth (if connected) Battery charging level Current pressure Pressure max. *2
3a		bar / psi	to change: bar / psi	*2
3b		bar / psi	to change: kN / lbf	3 sec.
3c		F 74 lbf F 369 lbf	F 74 lbf F 369 lbf	3 sec.
3d		F 74 lbf F 369 lbf	F 74 lbf F 369 lbf	3 sec.
4a		USER 3: RD3 Doppelklick	USER SELECT: RD3 Einfachklick	Doubleclick
4b		USER SELECT: RD3 Doppelklick	USER SELECT: RD3 Doppelklick	Singleclick enter menu
4c		USER SELECT: RD3 Doppelklick	USER SELECT: RD3 Doppelklick	Doubleclick select
4d		USER SELECT: RD3 Doppelklick	NEXT SERVICE: 9826 0Ps	Doubleclick confirmed
5		TOTAL: t = 0.07 h Q = 21.12 Ah n = 174	Cycles (until next service)	Since manufacturing: operating hours Capacity # crimps
6		RETURN	RETURN	3 sec.
7		RETURN	RETURN	3 sec.

- *1 Error codes:
- 1 Overcurrent fuse
 - 2 Overcurrent comparator
 - 3 Overheat board
 - 4 Overheat battery
 - 5 Battery empty, operation stop
 - 6 Faulty crimp motor in operation
 - 7 Faulty crimp motor not in operation
 - 8 Low battery
 - 9 Battery empty
 - 10 RTC battery low
 - 11 Tool deactivated
 - 12 Service necessary
 - 13 RTC not found
 - 14 BT unit not found
 - 16 Pressure sensor not found
 - 17 Burst pressure exceeded
 - 18 Battery temperature too low

- 1 Überstrom durch Überstromsicherung
- 2 Überstrom durch Komparator
- 3 Boardtemperatur zu hoch
- 4 Akkutemperatur zu hoch
- 5 Akkuspannung während der Operation zu gering
- 6 Fehlpressung bei laufendem Motor
- 7 Fehlpressung bei stehendem Motor
- 8 Niedrige Akkuspannung
- 9 Akku leer
- 10 RTC-Batterie leer
- 11 Werkzeug deaktiviert
- 12 Service nötig
- 13 RTC nicht verfügbar
- 14 BT-Modul nicht verfügbar
- 16 Drucksensor nicht verfügbar
- 17 Berstdruck überschritten
- 18 Akkutemperatur zu gering

*2 (2Hz)





Klauke i-press® Software

▶ www.klauke.com/connectivity



Klauke i-press® App

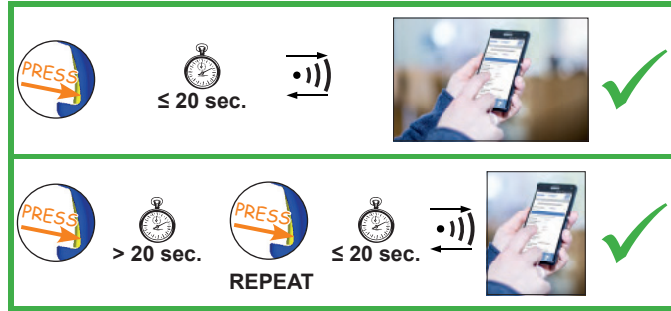

For US and Canada only

Le présent appareil est conforme aux CNR d'Industrie Canada applicables aux appareils radio exempts de licence. L'exploitation est autorisée aux deux conditions suivantes:

- (1) l'appareil ne doit pas produire de brouillage, et
- (2) l'utilisateur de l'appareil doit accepter tout brouillage radioélectrique subi, même si le brouillage est susceptible d'en compromettre le fonctionnement.

NOTICE:

Changes or modifications made to this equipment not expressly approved by Klauke may void the FCC authorization to operate this equipment.





ESG 25CFM

Klauke®

BEFORE WORK

DIN EN 50110

2 years
Warranty
World wide
Tool
Service
Klauke ASC

- 1.
- 2.
- 3.

Klauke

once a year

Klauke ASC
Authorised Service Center

3 years or
10.000 operations

Klauke ASC
Authorised Service Center

OLD
PART
REPLACEMENT
SAFETY
NEW

2 years
Warranty
World wide
Tool
Service
Klauke ASC

WEEE
2012/19/EU

klauke-weee-abholung@emerson.com

Klauke ASC
Authorised Service Center



			Wann/When/Quand/Quando/ cuándo/Wanneer/Когда/это происходит/Kiedy/quando	Warum/Why/Pourquoi/Porquê/ ¿por qué?/Waarom/Причина/ Dlaczego/Perché
 20 sec			nach Arbeitsvorgang after working cycle après opération de travail Después del proceso de trabajo após o processo de trabalho na bedrijfscyclus после цикла опрессовки po zakończeniu pracy dopo il processo di lavoro	
 20 sec/2Hz			nach Arbeitsvorgang after working cycle après opération de travail Después del proceso de trabajo após o processo de trabalho na bedrijfscyclus после цикла опрессовки po zakończeniu pracy dopo il processo di lavoro	Klauke ASC® Authorized Service Center
 20 sec/5Hz			während der Übertemperatur while exceeding the temp. limit pendant surchauffe en caso de temperatura excesiva durante a temperatura excessiva tijdens te hoge temperatuur при высокой температуре внутри корпуса przy przegrzaniu superando il limite di temperatura	Werkzeug zu heiß Unit too hot outil surchauffé Herramienta demasiado caliente ferramenta demasiado quente gereedschap te heet Перегрев инструмента urządzenie za gorące Utensile troppo caldo



Handgeführtes batteriebetriebenes Elektrowerkzeug Typ ESG 25CFM

Klauke[®]

(D) CE-17 - Konformitätserklärung. Wir erklären in alleiniger Verantwortlichkeit, daß dieses Produkt mit den folgenden Normen oder normativen Dokumenten übereinstimmt: EN 62841-1, EN ISO 12100, EN ISO 13857, EN 349, EN 28662-1, EN 61000-6-3, EN 61000-6-2, EN 1037 gemäß den Bestimmungen der Richtlinien 2006/42/EG, 2014/30/EU, 2011/65/EU

(GB) CE-17 - Declaration of conformity. We declare under our sole responsibility that this product is in conformity with the following standards or normative documents: EN 62841-1, EN ISO 12100, EN ISO 13857, EN 349, EN 28662-1, EN 61000-6-3, EN 61000-6-2, EN 1037 in accordance with the regulations of directives 2006/42/EG, 2014/30/EU, 2011/65/EU

(F) CE-17 - Déclaration de conformité. Nous déclarons sous notre seule responsabilité que ce produit est en conformité avec les normes ou documents normatifs suivants: EN 62841-1, EN ISO 12100, EN ISO 13857, EN 349, EN 28662-1, EN 61000-6-3, EN 61000-6-2, EN 1037 conformément aux réglementations des directives 2006/42/EG, 2014/30/EU, 2011/65/EU

(E) CE-17 - Declaración de conformidad. Declaramos bajo nuestra sola responsabilidad que este producto está en conformidad con las normas o documentos normativos siguientes: EN 62841-1, EN ISO 12100, EN ISO 13857, EN 349, EN 28662-1, EN 61000-6-3, EN 61000-6-2, EN 1037 de acuerdo con las regulaciones de las directivas 2006/42/EG, 2014/30/EU, 2011/65/EU

(I) CE-17 - Dichiarazione di conformità. Dichiariamo sotto la nostra esclusiva responsabilità che questo prodotto è conforme alle seguenti norme e documenti normativi: EN 62841-1, EN ISO 12100, EN ISO 13857, EN 349, EN 28662-1, EN 61000-6-3, EN 61000-6-2, EN 1037 conformemente alle disposizioni delle direttive 2006/42/EG, 2014/30/EU, 2011/65/EU

(P) CE-17 - Declaração de conformidade. Declaramos sob nossa exclusiva responsabilidade que este produto cumpre as seguintes normas ou documentos normativos: EN 62841-1, EN ISO 12100, EN ISO 13857, EN 349, EN 28662-1, EN 61000-6-3, EN 61000-6-2, EN 1037 conforme as disposições das directivas 2006/42/EG, 2014/30/EU, 2011/65/EU

(NL) CE-17 - Konformiteitsverklaring. Wij verklaren en wij stellen ons er alleen voor verantwoordelijk dat dit product voldoet aan de volgende normen of normatieve documenten: EN 62841-1, EN ISO 12100, EN ISO 13857, EN 349, EN 28662-1, EN 61000-6-3, EN 61000-6-2, EN 1037 overeenkomstig de bepalingen van de richtlijnen 2006/42/EG, 2014/30/EU, 2011/65/EU

(GR) CE-17 - ΔΗΛΩΣΗ ΣΥΜΜΟΡΦΩΣΗΣ Με αναληψη συλλογικης δηλωνομε: οτι το πορον προιον συμφωνα με τα παρακατω ποστυπα και με τα ηρωτηα που αναφερουνται στα σχετικα εγγραφα. EN 62841-1, EN ISO 12100, EN ISO 13857, EN 349, EN 28662-1, EN 61000-6-3, EN 61000-6-2, EN 1037 συμφωνα με τοχς κοινοισμους 2006/42/EG, 2014/30/EU, 2011/65/EU

(S) CE-17 - Konformitetsdeklaration. Vi förklarar på eget ansvar att denna produkt överensstämmer med följande normer eller normativa dokument: EN 62841-1, EN ISO 12100, EN ISO 13857, EN 349, EN 28662-1, EN 61000-6-3, EN 61000-6-2, EN 1037 enligt bestämmelserna i direktiverna 2006/42/EG, 2014/30/EU, 2011/65/EU

(DK) CE-17 - Konformitetserklæring. Vi erklærer under almindeligt ansvar at dette produkt er i overensstemmelse med følgende normer eller normative dokumenter: EN 62841-1, EN ISO 12100, EN ISO 13857, EN 349, EN 28662-1, EN 61000-6-3, EN 61000-6-2, EN 1037 i henhold til bestemmelserne i direktiverne 2006/42/EØF, 2014/30/EU, 2011/65/EU

(N) CE-17 - Konformitetserklæring. Vi erklærer på eget ansvarlighet at dette produkt er i overensstemmelse med følgende standarder eller standard-dokumenter: EN 62841-1, EN ISO 12100, EN ISO 13857, EN 349, EN 28662-1, EN 61000-6-3, EN 61000-6-2, EN 1037 i henhold til bestemmelserne i direktive ne 2006/42/EØF, 2014/30/EU, 2011/65/EU

(FIN) CE-17 - Todistus standardinmukaissuudesta. Asiaasta vastaavana todistamme täten, että tämä tuote on seuraavien standardien ja standardoimisasiakirjojen vaatimusten mukainen: EN 62841-1, EN ISO 12100, EN ISO 13857, EN 349, EN 28662-1, EN 61000-6-3, EN 61000-6-2, EN 1037 ja vastaa säädöksiä 2006/42/EG, 2014/30/EU, 2011/65/EU

(SK) CE-17 - Prehlásenie o zhode. Prehlasujeme na vlastnú zodpovednosť, že tieto produkty sú v súlade s nasledovnými normami: EN 62841-1, EN ISO 12100, EN ISO 13857, EN 349, EN 28662-1, EN 61000-6-3, EN 61000-6-2, EN 1037 a v zhode so smernicami 2006/42/EG, 2014/30/EU, 2011/65/EU

(PL) CE-17 - Zgodność z dyrektywami CE. Świadomi odpowiedzialności oświadczamy, że niniejszy produkt jest zgodny z następującymi normami lub dokumentacją normatywną: EN 62841-1, EN ISO 12100, EN ISO 13857, EN 349, EN 28662-1, EN 61000-6-3, EN 61000-6-2, EN 1037 zgodnie z postanowieniami wytycznych 2006/42/EG, 2014/30/EU, 2011/65/EU

(CZ) CE-17 - Prohlášení o shode. Prohlasujeme na vlastní zodpovednosť, že tyto produkty splňují následující normy nebo normativní listiny: EN 62841-1, EN ISO 12100, EN ISO 13857, EN 349, EN 28662-1, EN 61000-6-3, EN 61000-6-2, EN 1037; Ve shode se smernicami 2006/42/EG, 2014/30/EU, 2011/65/EU

(SLO) CE-17 - Izjava o skladnosti. S tem potrjujemo splošno odgovornost, da je ta izdelek narejen v skladu z navedenimi normami in standardi: EN 62841-1, EN ISO 12100, EN ISO 13857, EN 349, EN 28662-1, EN 61000-6-3, EN 61000-6-2, EN 1037 ter določbami in smernicami 2006/42/EG, 2014/30/EU, 2011/65/EU

(HR) CE-17 - Izjava o skladnosti. Pod punom odgovornošću izjavljujemo da je proizvod naveden u naslovu ovog dokumenta sukladan sa primijenjenim normama i normativnim dokumentima: EN 62841-1, EN ISO 12100, EN ISO 13857, EN 349, EN 28662-1, EN 61000-6-3, EN 61000-6-2, EN 1037 u skladu sa odredbama preporuka 2006/42/EG, 2014/30/EU, 2011/65/EU

(H) CE-17 - Megfelelőeségi nyilatkozat. Kéziműködtetésű elektromos kéziszerszámok: Teljes felelősséggel kijelentjük, hogy ezek a termékek a következő szabványokkal és irányelvekkel összhangban vannak: EN 62841-1, EN ISO 12100, EN ISO 13857, EN 349, EN 28662-1, EN 61000-6-3, EN 61000-6-2, EN 1037; és megfelelenek a rendeltetés szerinti 2006/42/EG, 2014/30/EU, 2011/65/EU irányelveknek.

(RO) CE-17 - Declarație de conformitate. Noi declarăm pe propria răspundere că acest produs este în conformitate cu următoarele norme și documente normative: EN 62841-1, EN ISO 12100, EN ISO 13857, EN 349, EN 28662-1, EN 61000-6-3, EN 61000-6-2, EN 1037; potrivit dispozițiilor directivelor 2006/42/EG, 2014/30/EU, 2011/65/EU

Remscheid, den 02.11.2017



Joh. - Christoph Schütz

Dipl.-Ing. Joh.-Christoph Schütz, CE-Beauftragter

(D) CE-'17 - Konformitätserklärung RED. Wir erklären in alleiniger Verantwortlichkeit, daß dieses Produkt mit den folgenden Normen oder normativen Dokumenten übereinstimmt: EN 60950-1, EN 301489-1, EN 301489-17, EN 300328 V2.1.1, EN 62479 gemäß den Bestimmungen der Richtlinien 2014/53/EU, 2011/65/EU

(GB) CE-'17 - Declaration of conformity RED. We declare under our sole responsibility that this product is in conformity with the following standards or normative documents: EN 60950-1, EN 301489-1, EN 301489-17, EN 300328 V2.1.1, EN 62479 in accordance with the regulations of directives 2014/53/EU, 2011/65/EU

(F) CE-'17 - Déclaration de conformité RED. Nous déclarons sous notre seule responsabilité que ce produit est en conformité avec les normes ou documents normatifs suivants: EN 60950-1, EN 301489-1, EN 301489-17, EN 300328 V2.1.1, EN 62479 conformément aux réglementations des directives 2014/53/EU, 2011/65/EU

(E) CE-'17 - Declaración de conformidad RED. Declaramos bajo nuestra sola responsabilidad que este producto está en conformidad con las normas o documentos normativos siguientes: EN 60950-1, EN 301489-1, EN 301489-17, EN 300328 V2.1.1, EN 62479 de acuerdo con las regulaciones de las directivas 2014/53/EU, 2011/65/EU

(I) CE-'17 - Dichiarazione di conformità RED. Dichiariamo sotto la nostra esclusiva responsabilità che questo prodotto è conforme alle seguenti norme e documenti normativi: EN 60950-1, EN 301489-1, EN 301489-17, EN 300328 V2.1.1, EN 62479 conformemente alle disposizioni delle direttive 2014/53/EU, 2011/65/EU

(P) CE-'17 - Declaração de conformidade RED. Declaramos sob nossa exclusiva responsabilidade que este produto cumpre as seguintes normas ou documentos normativos: EN 60950-1, EN 301489-1, EN 301489-17, EN 300328 V2.1.1, EN 62479 conforme as disposições das directivas 2014/53/EU, 2011/65/EU

(NL) CE-'17 - Konformiteitsverklaring RED. Wij verklaren en wij stellen ons er alleen voor verantwoordelijk dat dit produkt voldoet aan de volgende normen of normatieve documenten: EN 60950-1, EN 301489-1, EN 301489-17, EN 300328 V2.1.1, EN 62479 overeenkomstig de bepalingen van de richtlijnen 2014/53/EU, 2011/65/EU

(GR) CE-'17 - ΔΗΛΩΣΗ ΣΥΜΜΟΡΦΩΣΗΣ Μ RED. ϵ αναληψη συνολικης δηλωσιμε: οτι το πορον προιον συμφωρει με τα παρακατω ποοτητα και με τα ηροτινη ηου αναφερονται οτα σχετικα εγγραφα ∞ EN 60950-1, EN 301489-1, EN 301489-17, EN 300328 V2.1.1, EN 62479 σύμφωνα με τοxα κοινουμοιου 2014/53/EU, 2011/65/EU

(S) CE-'17 - Konformitetsdeklaration RED. Vi förklarar på eget ansvar att denna produkt överensstämmer med följande normer eller normativa dokument: EN 60950-1, EN 301489-1, EN 301489-17, EN 300328 V2.1.1, EN 62479 enligt bestämmelserna i direktiverna 2014/53/EU, 2011/65/EU

(DK) CE-'17 - Konformitetserklæring RED. Vi erklærer under almindeligt ansvar at dette produkt er i overensstemmelse med følgende normer eller normative dokumenter: EN 60950-1, EN 301489-1, EN 301489-17, EN 300328 V2.1.1, EN 62479 i henhold til bestemmelserne i direktiverne 2014/53/EU, 2011/65/EU

(N) CE-'17 - Konformitetserklæring RED. Vi erklærer på eget ansvar at dette produkt er i overensstemmelse med følgende standarder eller standard-dokumenter: EN 60950-1, EN 301489-1, EN 301489-17, EN 300328 V2.1.1, EN 62479 i henhold til bestemmelserne i direktive ne 2014/53/EU, 2011/65/EU

(FIN) CE-'17 - Todistus standardinmukaisuudesta RED. Asiasta vastaavana todistamme läten, että tämä tuote on seuraavien standardien ja standardoimisasiakirjojen vaatimusten mukainen: EN 60950-1, EN 301489-1, EN 301489-17, EN 300328 V2.1.1, EN 62479 ja vastaa säädöksiä 2014/53/EU, 2011/65/EU

(SK) CE-'17 - Prehlásenie o zhode RED. Prehlasujeme na vlastnú zodpovednosť, že tieto produkty sú v súlade s nasledovnými normami: EN 60950-1, EN 301489-1, EN 301489-17, EN 300328 V2.1.1, EN 62479 a v zhode so smernicami 2014/53/EU, 2011/65/EU

(PL) CE-'17 - Zgodność z dyrektywami RED. Świadomi odpowiedzialności oświadczamy, że niniejszy produkt jest zgodny z następującymi normami lub dokumentacja normatywna: EN 60950-1, EN 301489-1, EN 301489-17, EN 300328 V2.1.1, EN 62479 zgodnie z postanowieniami wytycznych 2014/53/EU, 2011/65/EU

(CZ) CE-'17 - Prohlášení o shode RED. Prohlasujeme na vlastní zodpovednosť, že tyto produkty splňují následující normy nebo normativní listiny: EN 60950-1, EN 301489-1, EN 301489-17, EN 300328 V2.1.1, EN 62479 Ve shode se smernicemi 2014/53/EU, 2011/65/EU

(SLO) CE-'17 - Izjava o skladnosti RED. S tem potrjujemo splošno odgovornost, da je ta izdelek narejen v skladu z navedenimi normami in standardi EN 60950-1, EN 301489-1, EN 301489-17, EN 300328 V2.1.1, EN 62479 ter določbami in smernicami 2014/53/EU, 2011/65/EU

(HR) CE-'17 - Izjava o skladnosti RED. Pod punom odgovornošću izjavljujemo da je proizvod naveden u naslovu ovog dokumenta skladan sa primijenjenim normama i normativnim dokumentima : EN 60950-1, EN 301489-1, EN 301489-17, EN 300328 V2.1.1, EN 62479 u skladu sa odredbama preporuka 2014/53/EU, 2011/65/EU

(H) CE-'17 - Megfelelősségi nyilatkozat RED. Kéziműködtetésű elektromos kéziszerszámok. Teljes felelősséggel kijelentjük, hogy ezek a termékek a következő szabványokkal és irányelvekkel összhangban vannak: EN 60950-1, EN 301489-1, EN 301489-17, EN 300328 V2.1.1, EN 62479 és megfelelnek a rendeltetés 2014/53/EU, 2011/65/EU irányelveknek.

(RO) CE-'17 - Declarație de conformitate RED. Noi declarăm pe propria răspundere că acest produs este în conformitate cu următoarele norme și documente normative: EN 60950-1, EN 301489-1, EN 301489-17, EN 300328 V2.1.1, EN 62479 potrivit dispozițiilor directivelor 2014/53/EU, 2011/65/EU

Remscheid, den 01.11.2017

Dipl.-Ing. Joh.-Christoph Schütz, CE-Beauftragter