

G-PRESS Pipe and Fittings Selection and Installation Technical Document

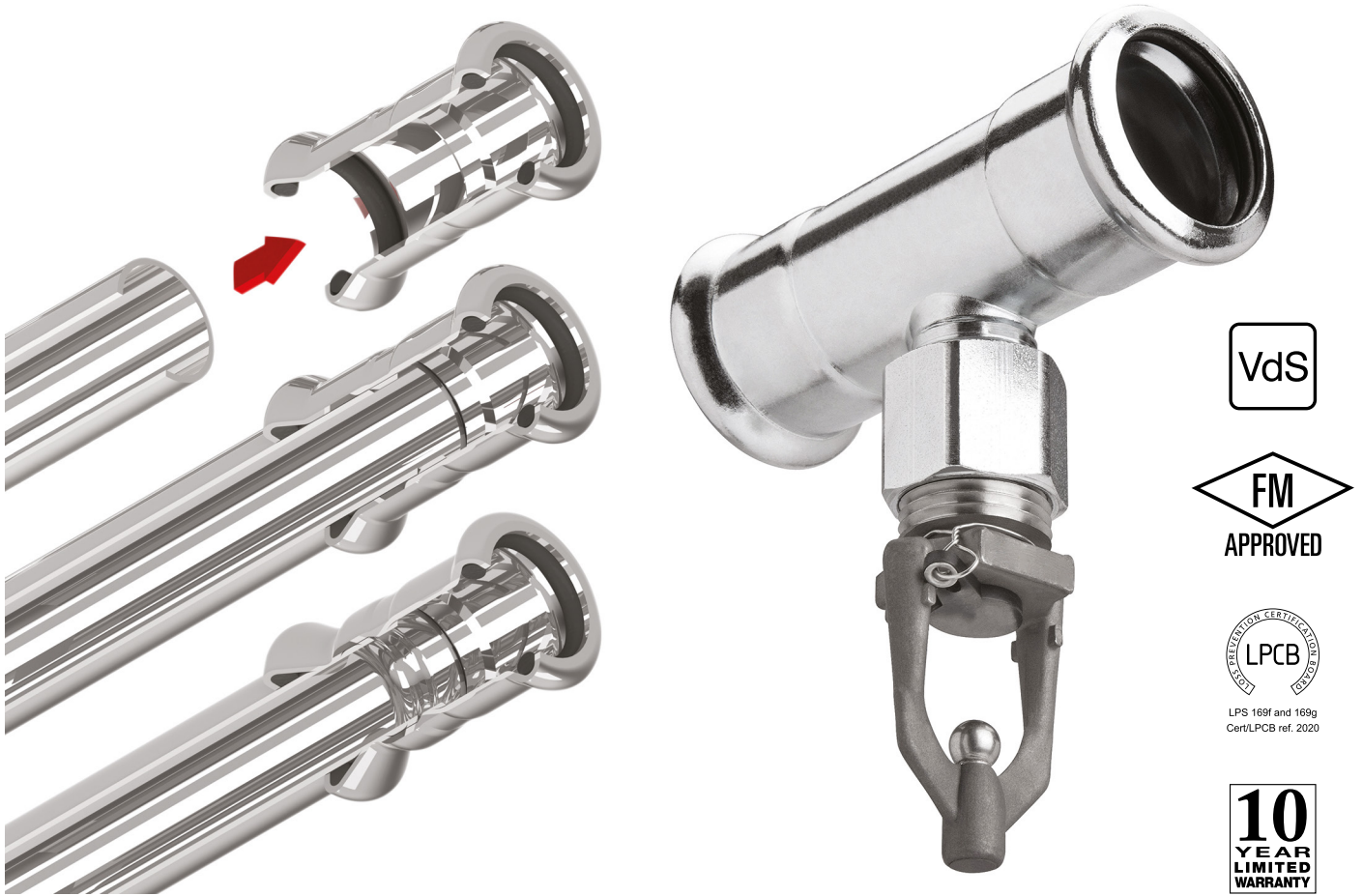

TFP2244
APRIL 2021

CONTENTS

1	ADVANTAGES OF G-PRESS PIPING SYSTEMS.	4
2	GENERAL DESCRIPTION.	5
2.1	G-PRESS FITTING CONNECTION.	6
2.2	G-PRESS FITTINGS	6
2.3	G-PRESS LEAK-BEFORE-PRESS (LBP) SEALING RING.	6
2.4	G-PRESS PIPE	6
3	G-PRESS SYSTEM APPROVALS.	7
3.1	VdS	7
3.2	FM	7
3.3	LPCB	7
4	G-PRESS PART NUMBER SELECTION.	8
4.1	PIPE.	8
4.2	FITTINGS.	8
5	G-PRESS PIPE DATA	8
5.1	SPRINKLER PIPE, STAINLESS STEEL 1.4401.	9
5.2	SPRINKLER PIPE, STAINLESS STEEL 1.4521.	9
6	G-PRESS FITTINGS DATA	10
6.1	FIGURE G05 STRAIGHT COUPLING (PRESS x PRESS).	10
6.2	FIGURE G10 SLIP COUPLING (PRESS x PRESS).	10
6.3	FIGURE G11 SLIP COUPLING (PRESS x FEMALE PIPE THREAD)	11
6.4	FIGURE G15 ELBOW 90° (PRESS x PRESS)	11
6.5	FIGURE G16 ELBOW 90° (PRESS x PLAIN-END)	12
6.6	FIGURE G18 ELBOW 90° (PRESS x FEMALE PIPE THREAD)	12
6.7	FIGURE G20 ELBOW 45° (PRESS x PRESS)	13
6.8	FIGURE G21 ELBOW 45° (PRESS x PLAIN-END)	13
6.9	FIGURE G35 TEE EQUAL (PRESS x PRESS x PRESS)	14
6.10	FIGURE G36 TEE REDUCING (PRESS x PRESS x PRESS)	14
6.11	FIGURE G37 THREADED TEE (PRESS x FEMALE PIPE THREAD x PRESS)	15
6.12	FIGURE G40 REDUCER (PRESS x MALE PRESS)	15
6.13	FIGURE G45 STRAIGHT CONNECTOR (PRESS x MALE PIPE THREAD)	16
6.14	FIGURE G46 STRAIGHT CONNECTOR (PRESS x FEMALE PIPE THREAD).	16
6.15	FIGURE G48 GROOVED TRANSITION (PRESS x GROOVE)	17
6.16	FIGURE G50 STOP END (PRESS).	17

6.17 FIGURE G52 TRANSITION FOR FLANGED (PRESS x FLANGE) 18

6.18 G-PRESS LBP SEALING RING 18

7 PRESS TOOLS FOR G-PRESS FITTINGS 19

7.1 ACO203BT COMFORT LINE PRESSING TOOL 19

7.2 ACO403BT COMFORT LINE PRESSING TOOL 20

7.3 PRESS TOOL AND ACCESSORY PART NUMBERS 21

8 G-PRESS PIPE AND FITTING ASSEMBLY 22

8.1 PRELIMINARY REMARK 22

8.2 TRANSPORT AND STORAGE 22

8.3 ASSEMBLY PROCEDURE 22

9 INSERTION DEPTH AND MINIMUM DISTANCE BETWEEN FITTINGS 24

10 PRESS TOOL AND FITTING CLEARANCES 24

11 G-PRESS TECHNICAL DATA 25

11.1 WATER MIST AND FIXED SPRINKLER SYSTEMS..... 25

11.2 G-PRESS LEAK BEFORE PRESS (LBP) SEALING RING 26

11.3 G-PRESS STAINLESS STEEL WATER MIST AND SPRINKLER PIPE..... 27

12 CORROSION 28

12.1 INTERNAL CORROSION 28

12.2 ELECTROCHEMICAL CORROSION 28

12.3 STRAY CURRENTS..... 29

12.4 EXTERNAL CORROSION..... 29

13 GENERAL INSTRUCTIONS FOR USE 29

13.1 FLUSHING THE SYSTEM..... 29

13.2 FILLING AND BLEEDING WET PIPE SYSTEMS..... 29

13.3 PRESSURE TESTING..... 29

14 FLOW LOSS..... 30

14.1 CONTINUOUS PRESSURE DROP..... 30

14.2 LOCAL PRESSURE DROP..... 30

14.2.1 DIRECT ANALYTICAL METHOD 31

14.2.2 EQUIVALENT LENGTH METHOD 31

15 WARRANTY G-PRESS 32

1 ADVANTAGES OF G-PRESS PIPING SYSTEMS

In the building installation market the advantages of press systems over traditional solutions like black steel and threaded fittings have long been recognized. The same advantages apply for sprinkler installations, most importantly:



Dependable, tested and approved by major Fire Protection approval agencies



Cost effective, reduces installation time

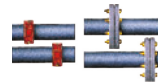

Space-saving, occupies far less space than systems assembled by traditional threaded, welded or flanged joining methods



Reduces installation costs



Weight-saving, light materials reduce system weight up to 50% compared to traditional piping systems



Simplicity, requires only a press tool for installation

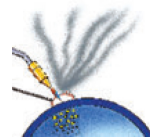

Stainless steel construction reduces possibility of introducing foreign materials into the pipeline



Safe installation, absence of high heat and flame otherwise caused by welding equipment



Healthy, installation does not lead to hazardous fumes in work area



Warranty, backed by a 10-year limited warranty



Workmanship, renowned quality components manufactured in accordance with ISO 9001 QA standard



Reliable Connection, all fittings up to 54 mm feature Leak Before Press (LBP) Seals



Compatible environments, can be installed in hazardous areas without special precautions

2 GENERAL DESCRIPTION

Tyco Fire Protection Products G-PRESS Pipe and Fittings offer a complete solution for water mist and sprinkler fire protection system installations.

Press connection technology is well established, addressing the need for quick and precise leak-free system piping installation together with third-party approvals for increased safety and security. G-PRESS Pipe and Fittings are designed to meet these goals and have earned approval from primary agencies for use in water-based fire protection systems.

NOTICE

The G-PRESS Piping System described herein must be installed and maintained in compliance with this document and with applicable standards in addition to the requirements of any authorities having jurisdiction. Failure to do so may impair the performance of these devices.

The design of individual water mist systems can vary considerably, depending on the characteristics and nature of the hazard and the basic purpose of the water mist system. Because of these variations, the design of water mist systems for fire protection must only be performed by experienced designers who thoroughly understand the limitations as well as capabilities of such systems.

It is the responsibility of the designer to select products suitable for the intended service and to ensure that pressure ratings and performance data is not exceeded. Always read and understand the installation instructions. Never remove any piping components nor correct or modify any piping deficiencies without first depressurizing and draining the system.

Training provided by Tyco Fire Protection Products (TFPP) is mandatory prior to bidding, designing, procurement of components, installation and maintaining of G-PRESS Piping system. For gaining such training contact TFPP Technical Services.

The owner is responsible for maintaining their fire protection system and devices in proper operating condition. Contact the installing contractor or product manufacturer with any questions.

IMPORTANT

Refer to Technical Data Sheet TFP2300 for warnings pertaining to regulatory and health information.

Always refer to Technical Data Sheet TFP700 for the “INSTALLER WARNING” that provides cautions with respect to handling and installation of sprinkler systems and components. Improper handling and installation can permanently damage a sprinkler system or its components and cause the sprinkler to fail to operate in a fire situation or cause it to operate prematurely.

2 GENERAL DESCRIPTION

2.1 G-PRESS FITTING CONNECTION

The connection between the pipe and fitting is created by pressure using a pressing tool. The packing sleeve is deformed and adapts to the surface of the pipe, which is then pressed in turn against the sealing rings on the surface of the fitting. This ensures the sealing effect and prevents the pipe from disconnecting.

All G-PRESS Fitting connections feature the “M” contour when properly pressed.

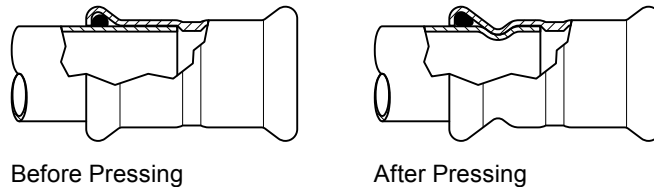

2.2 G-PRESS FITTINGS

G-PRESS Fittings are manufactured from stainless steel material no. 1.4404.



2.3 G-PRESS LEAK-BEFORE-PRESS (LBP) SEALING RING

All G-PRESS Fittings up to 54 mm are supplied with an EPDM Sealing Ring which ensures leaking during pressure testing if the connection is not pressed.



2.4 G-PRESS PIPE

G-Press pipe is thin-walled precision pipe corresponding to EN10305-3 (previously DIN 2394/NEN 1982), made from stainless steel DIN material number 1.4401 (SS1) or 1.4521 (SS3).



3 G-PRESS SYSTEM APPROVALS

TABLE 3.1: VdS APPROVALS

Size mm	Dry System	Wet System
22	16.0 bar / 230 psi	16.0 bar / 230 psi
28	16.0 bar / 230 psi	16.0 bar / 230 psi
54	16.0 bar / 230 psi	16.0 bar / 230 psi
88.9	12.5 bar / 175 psi	12.5 bar / 175 psi

Please note that for VdS applications there is a limitation to the hazard class. The products are approved for up to and including ordinary hazard class 3 (OH3) and partially including hazard class 4 (OH4, concert, exhibition halls, theatres incl. movie theatres).

TABLE 3.2: FM APPROVALS

Size mm	Dry System	Wet System
22	12.5 bar / 175 psi	12.5 bar / 175 psi
28	12.5 bar / 175 psi	12.5 bar / 175 psi
54	12.5 bar / 175 psi	12.5 bar / 175 psi
88.9	Not Approved	12.5 bar / 175 psi

TABLE 3.3: LPCB APPROVALS

Size mm	Dry System	Wet System
22	Not Approved	16.0 bar / 230 psi
28	Not Approved	16.0 bar / 230 psi
54	Not Approved	16.0 bar / 230 psi
88.9	Not Approved	Not Approved

Please note that for LPCB applications there is a limitation to the hazard class. The products are approved for up to and including ordinary hazard class 3 (OH3)

4 G-PRESS PART NUMBER SELECTION

TABLE 4.1: PIPE PART NUMBER SELECTION





Digit 01	P	<table border="1"> <tr> <th>Size mm</th> <th>Digits for Size</th> </tr> <tr> <td>22</td> <td>22</td> </tr> <tr> <td>28</td> <td>28</td> </tr> <tr> <td>54</td> <td>54</td> </tr> <tr> <td>88.9</td> <td>89</td> </tr> </table>	Size mm	Digits for Size	22	22	28	28	54	54	88.9	89	<table border="1"> <tr> <th>Finish</th> <th>Digits for Finish</th> </tr> <tr> <td>Stainless Steel 1.4401</td> <td>SS1</td> </tr> <tr> <td>Stainless Steel 1.4521</td> <td>SS3</td> </tr> </table>	Finish	Digits for Finish	Stainless Steel 1.4401	SS1	Stainless Steel 1.4521	SS3	 Example 1: PIPE89SS1 ↓ ↓ ↓ Figure No. Size Finish Figure: PIPE Size: 88.9 Finish: Stainless Steel 1.4401	 Example 2: PIPE54SS3 ↓ ↓ ↓ Figure No. Size Finish Figure: PIPE Size: 54 Finish: Stainless Steel 1.4521
Size mm	Digits for Size																				
22	22																				
28	28																				
54	54																				
88.9	89																				
Finish	Digits for Finish																				
Stainless Steel 1.4401	SS1																				
Stainless Steel 1.4521	SS3																				
Digit 02	I																				
Digit 03	P																				
Digit 04	E																				
Digit 05	Size																				
Digit 06	Size																				
Digit 07	Size (optional)																				
Digit 08	Finish																				
Digit 09	Finish																				
Digit 10	Finish (optional)																				

TABLE 4.2: FITTING PART NUMBER SELECTION

Digit 01	Figure Number	<table border="1"> <tr> <th>Size mm</th> <th>Digits for Size</th> </tr> <tr> <td>22</td> <td>22</td> </tr> <tr> <td>28</td> <td>28</td> </tr> <tr> <td>54</td> <td>54</td> </tr> <tr> <td>88.9</td> <td>89</td> </tr> </table>	Size mm	Digits for Size	22	22	28	28	54	54	88.9	89	<table border="1"> <tr> <th>Threaded or Grooved Outlet Size in.</th> <th>Digits for Outlet Size</th> </tr> <tr> <td>1/2</td> <td>TB</td> </tr> <tr> <td>1</td> <td>TD</td> </tr> <tr> <td>2</td> <td>TG</td> </tr> <tr> <td>3</td> <td>TI</td> </tr> </table>	Threaded or Grooved Outlet Size in.	Digits for Outlet Size	1/2	TB	1	TD	2	TG	3	TI	 Example 1: G3754TB544 ↓ ↓ ↓ ↓ ↓ Figure No. Size Outlet Size Size Finish Figure: G37 Size: 54 mm x 1/2 in. x 54 mm Finish: Stainless Steel 1.4404	 Example 2: G10284 ↓ ↓ ↓ Figure No. Size Finish Figure: G10 Size: 28 mm Finish: Stainless Steel 1.4404
Size mm	Digits for Size																								
22	22																								
28	28																								
54	54																								
88.9	89																								
Threaded or Grooved Outlet Size in.	Digits for Outlet Size																								
1/2	TB																								
1	TD																								
2	TG																								
3	TI																								
Digit 02	Figure Number																								
Digit 03	Figure Number																								
Digit 04	Size																								
Digit 05	Size																								
Digit 06	Size (optional)																								
Digit 07	Size (optional)																								
Digit 08	Size (optional)																								
Digit 09	Size (optional)																								
Digit 10	Finish																								
<table border="1"> <tr> <th>Finish</th> <th>Digits for Finish</th> </tr> <tr> <td>Stainless Steel 1.4404</td> <td>4</td> </tr> </table>		Finish	Digits for Finish	Stainless Steel 1.4404	4																				
Finish	Digits for Finish																								
Stainless Steel 1.4404	4																								

5 G-PRESS PIPE DATA

TABLE 5.1: G-PRESS SPRINKLER PIPE, STAINLESS STEEL 1.4401

Part Number	Outside Ø mm	Wall Thickness (B) mm	Length (A) mm	Weight / mtr	Approval
PIPE22SS1	22.0	1.2	6000	0.624	FM/VdS/LPCB
PIPE28SS1	28.0	1.2	6000	0.790	FM/VdS/LPCB
PIPE54SS1	54.0	1.5	6000	2.098	FM/VdS/LPCB
PIPE89SS1	88.9	2.0	6000	4.460	FM/VdS

TABLE 5.2: G-PRESS SPRINKLER PIPE, STAINLESS STEEL 1.4521

Part Number	Outside Ø mm	Wall Thickness (B) mm	Length (A) mm	Weight / mtr	Approval
PIPE22SS3	22.0	1.2	6000	0.624	FM/VdS
PIPE28SS3	28.0	1.2	6000	0.790	FM/VdS
PIPE54SS3	54.0	1.5	6000	2.098	FM/VdS

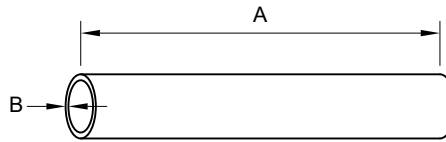

6 G-PRESS FITTINGS DATA

TABLE 6.1: G-PRESS FIGURE G05 STRAIGHT COUPLING (PRESS X PRESS)

Part Number	Dimensions mm	A mm	B mm	⌀ / mtr	Approval
G05224	22x22	52.0	10.0	0.056	FM/VdS/LPCB
G05284	28x28	56.2	10.2	0.075	FM/VdS/LPCB
G05544	54x54	83.0	13.0	0.221	FM/VdS/LPCB
G05894	88.9x88.9	163.0	37.0	0.837	FM/VdS



TABLE 6.2: G-PRESS FIGURE G10 SLIP COUPLING (PRESS X PRESS)

Part Number	Dimensions mm	A mm	B mm	⌀ / mtr	Approval
G10224	22x22	84.0	25.0	0.084	FM/VdS/LPCB
G10284	28x28	91.2	30.0	0.112	FM/VdS/LPCB
G10544	54x54	140.0	40.0	0.368	FM/VdS/LPCB
G10894	88.9x88.9	258.0	70.0	1.196	FM/VdS

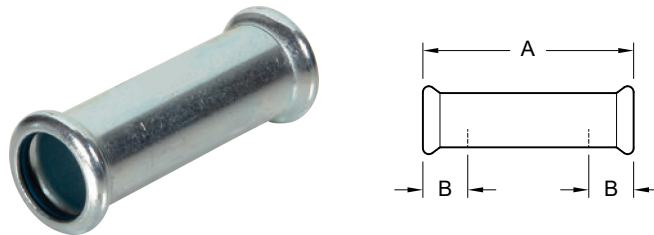

6 G-PRESS FITTINGS DATA

TABLE 6.3: G-PRESS FIGURE G11 SLIP COUPLING (PRESS X FEMALE PIPE THREAD)

Part Number	Dimensions mm	A mm	B mm	C mm	ΔL mm	ρ_{90} / mtr	Approval
G1122TB4	22xRp1/2	89.0	25.0	15.0	40.0	0.133	FM/VdS/LPCB
G1128TB4	28xRp1/2	91.0	30.0	15.0	40.0	0.172	FM/VdS/LPCB

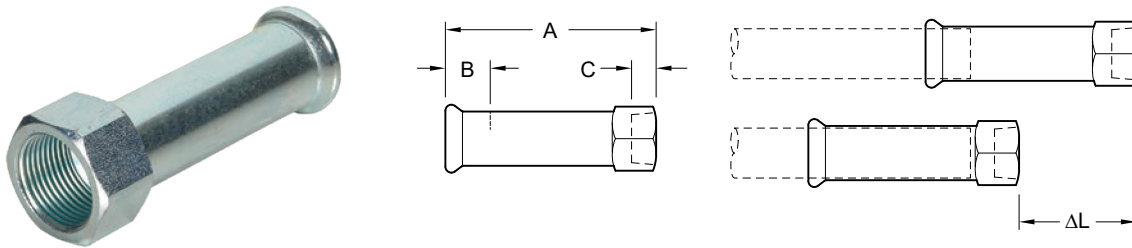
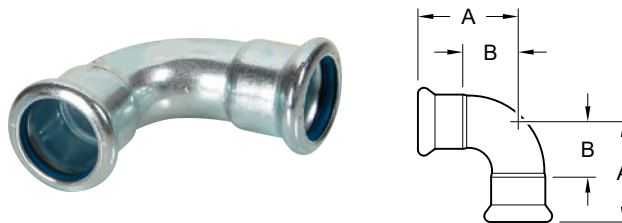

TABLE 6.4: G-PRESS FIGURE G15 ELBOW 90° (PRESS X PRESS)

Part Number	Dimensions mm	A mm	B mm	ρ_{90} / mtr	Approval
G15224	22x22	51.0	30.0	0.109	FM/VdS/LPCB
G15284	28x28	60.1	37.1	0.165	FM/VdS/LPCB
G15544	54x54	105.0	70.0	0.220	FM/VdS/LPCB
G15894	88.9x88.9	175.0	112.0	1.325	FM/VdS



6 G-PRESS FITTINGS DATA

TABLE 6.5: G-PRESS FIGURE G16 ELBOW 90° (PRESS X PLAIN-END)

Part Number	Dimensions mm	A mm	B mm	C mm	kg / mtr	Approval
G16284	28x28	60.1	37.1	65.5	0.158	FM/VdS/LPCB
G16544	54x54	105.0	70.0	110.6	0.226	FM/VdS/LPCB
G16894	88.9x88.9	174.0	112.0	190.0	1.371	FM/VdS

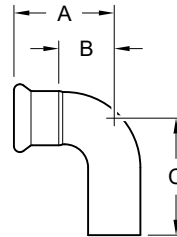
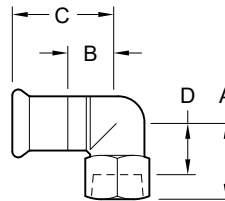

TABLE 6.6: G-PRESS G18 ELBOW 90° (PRESS X FEMALE PIPE THREAD)

Part Number	Dimensions mm	A mm	B mm	C mm	D mm	kg / mtr	Approval
G1822TB4	22xRp1/2	31.0	24.0	45.0	16.0	0.285	FM/VdS/LPCB
G1828TB4	28xRp1/2	35.0	24.5	47.5	16.0	0.320	FM/VdS/LPCB
G1828TD4	28xRp1	37.0	31.5	54.5	17.5	0.260	FM/VdS/LPCB



6 G-PRESS FITTINGS DATA

TABLE 6.7: G-PRESS FIGURE G20 ELBOW 45° (PRESS X PRESS)

Part Number	Dimensions mm	A mm	B mm	kg / mtr	Approval
G20224	22x22	35.2	14.2	0.130	FM/VdS/LPCB
G20284	28x28	40.2	17.2	0.173	FM/VdS/LPCB
G20544	54x54	66.9	31.9	0.256	FM/VdS/LPCB
G20894	88.9x88.9	112.0	49.0	0.991	FM/VdS

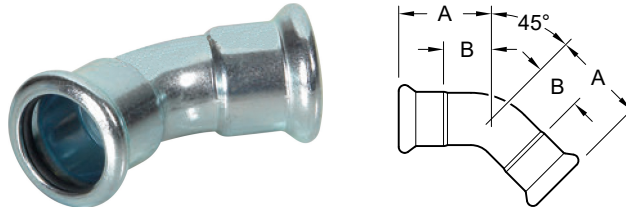
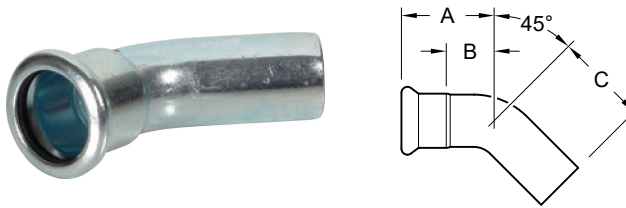

TABLE 6.8: G-PRESS FIGURE G21 ELBOW 45° (PRESS X PLAIN-END)

Part Number	Dimensions mm	A mm	B mm	C mm	kg / mtr	Approval
G21284	28x28	40.2	17.2	45.6	0.155	FM/VdS/LPCB
G21544	54x54	66.9	31.9	72.5	0.256	FM/VdS/LPCB
G21894	88.9x88.9	112.0	49.0	131.0	0.998	FM/VdS



6 G-PRESS FITTINGS DATA

TABLE 6.9: G-PRESS FIGURE G35 TEE EQUAL (PRESS X PRESS X PRESS)

Part Number	Dimensions mm	A mm	B mm	C mm	D mm	kg / mtr	Approval
G35224	22x22x22	39.5	18.5	43.5	22.5	0.108	FM/VdS/LPCB
G35284	28x28x28	44.5	21.5	48.5	25.5	0.150	FM/VdS/LPCB
G35544	54x54x54	71.0	36.0	72.5	37.5	0.430	FM/VdS/LPCB
G35894	88.9x88.9x88.9	131.0	68.0	127.0	64.0	1.617	FM/VdS

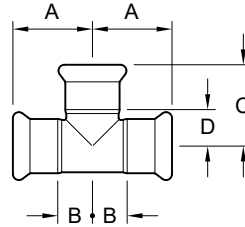
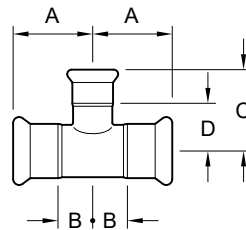

TABLE 6.10: G-PRESS FIGURE G36 TEE REDUCING (PRESS X PRESS X PRESS)

Part Number	Dimensions mm	A mm	B mm	C mm	D mm	kg / mtr	Approval
G362822284	28x22x28	44.5	21.5	46.5	25.5	0.139	FM/VdS/LPCB
G365422544	54x22x54	71.0	36.0	58.5	37.5	0.350	FM/VdS/LPCB
G365428544	54x28x54	71.0	36.0	60.5	37.5	0.360	FM/VdS/LPCB
G368922894	88.9x22x88.9	131.0	68.0	76.0	53.0	1.256	FM/VdS
G368928894	88.9x28x88.9	131.0	68.0	76.0	52.0	1.244	FM/VdS
G368954894	88.9x54x88.9	131.0	68.0	93.0	56.0	1.271	FM/VdS



6 G-PRESS FITTINGS DATA

TABLE 6.11: G-PRESS FIGURE G37 THREADED TEE (PRESS X FEMALE PIPE THREAD X PRESS)

Part Number	Dimensions mm	A mm	B mm	C mm	D mm	kg / mtr	Approval
G3722TB224	22xRp1/2x22	39.5	18.5	37.0	22.0	0.128	FM/VdS/LPCB
G3728TB284	28xRp1/2x28	44.5	21.5	40.0	25.0	0.158	FM/VdS/LPCB
G3728TD284	28xRp1x28	44.5	21.5	46.0	27.5	0.212	FM/VdS/LPCB
G3754TB544	54xRp1/2x54	71.0	36.0	52.0	37.0	0.370	FM/VdS/LPCB
G3754TD544	54xRp1x54	71.0	36.0	58.0	39.0	0.673	FM/VdS/LPCB

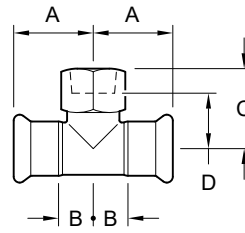
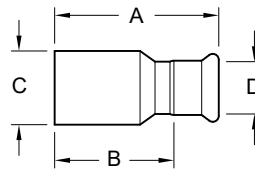

TABLE 6.12: G-PRESS FIGURE G40 REDUCER (PRESS X MALE PRESS)

Part Number	Dimensions mm	A mm	B mm	C mm	D mm	kg / mtr	Approval
G4028224	28x22	61.2	40.2	28.0	22.0	0.062	FM/VdS/LPCB
G4054222	54x22	96.5	75.5	54.0	22.0	0.203	FM/VdS/LPCB
G4054284	54x28	95.5	72.5	54.0	28.0	0.197	FM/VdS/LPCB
G4089544	88.9x54	156.0	119.0	88.9	54.0	0.586	FM/VdS



6 G-PRESS FITTINGS DATA

TABLE 6.13: G-PRESS FIGURE G45 STRAIGHT CONNECTOR (PRESS X MALE PIPE THREAD)

Part Number	Dimensions mm	A mm	B mm	kg / mtr	Approval
G4528TD4	28xR1	48.0	25.0	0.133	FM/VdS/LPCB
G4554TG4	54xR2	69.0	34.0	0.394	FM/VdS/LPCB

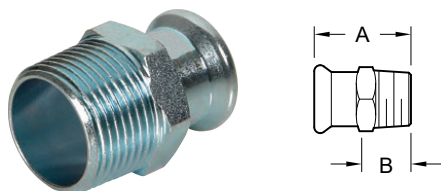

TABLE 6.14: G-PRESS FIGURE G46 STRAIGHT CONNECTOR (PRESS X FEMALE PIPE THREAD)

Part Number	Dimensions mm	A mm	B mm	kg / mtr	Approval
G4628TB4	28xRp1/2	38.0	2.0	0.157	FM/VdS/LPCB
G4628TD4	28xRp1	44.6	8.6	0.160	FM/VdS/LPCB
G4654TG4	54xRp2	63.0	10.0	0.491	FM/VdS/LPCB



6 G-PRESS FITTINGS DATA

TABLE 6.15: G-PRESS FIGURE G48 GROOVED TRANSITION (PRESS X GROOVE)

Part Number	Dimensions mm	A mm	B mm	C mm	kg / mtr	Approval
G4828TD4	28x33.7	72.5	33.7	26.5	0.140	FM/VdS/LPCB
G4854TG4	54x60.3	96.5	60.3	26.5	0.318	FM/VdS/LPCB
G4889TI4	88.9x88.9	100.0	88.9	36.0	0.590	FM/VdS/LPCB

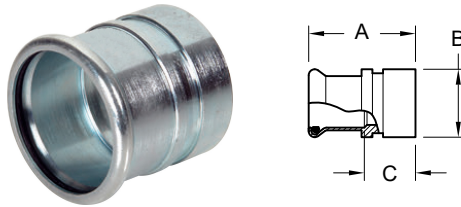

Note: Recommended to use Figure G48 with GRINNELL® G-FIRE Grooved Couplings.

Important note for FM Approved installations:

When connecting the G-PRESS system to a Grooved system it is mandatory to use the G48 Grooved Transition.

TABLE 6.16: G-PRESS FIGURE G50 STOP END (PRESS)

Part Number	Dimensions mm	A mm	B mm	kg / mtr	Approval
G50224	22.0	24.1	31.1	0.032	FM/VdS/LPCB
G50284	28.0	26.1	3.05	0.043	FM/VdS/LPCB
G50544	54.0	41.6	6.55	0.152	FM/VdS/LPCB
G50894	88.9	107.0	44.0	0.559	FM/VdS

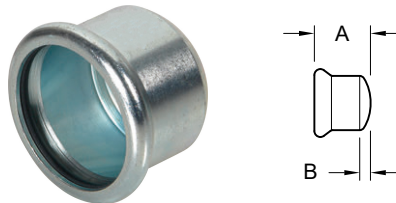

6 G-PRESS FITTINGS DATA

TABLE 6.17: G-PRESS FIGURE G52 TRANSITION FOR FLANGED (PRESS X FLANGE)

Part Number	Dimensions mm	PN bar	A mm	B mm	C mm	D mm	⌀ / mtr	Approval
G52894	88.9	16	160.0	200.0	84.0	147.0	4.370	FM/VdS

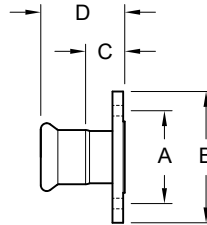

When connecting the G-PRESS system to a flanged system or component it is mandatory to use the Figure G52 Transition for Flanged with separately ordered DN80 Flange Bolting Kit, Part Number FLN0898 (includes bolts, washers, nuts and gasket).

TABLE 6.18: G-PRESS LBP SEALING RING

Part Number	Dimensions mm
G50224	22.0
G50284	28.0
G50544	54.0



7 PRESS TOOLS FOR G-PRESS FITTINGS

Only press tools listed in the G-PRESS Piping System agency approvals should be used to install G-Press fittings. These authorized press tools consist of the pressing units and accompanying press jaws and collars outlined below. The ACO203BT pressing units are designed for use with 22 mm to 54 mm pipe sizes, and the ACO403BT for use with 88.9 mm pipe size. To ensure a completely tight connection, the pressing units should be used with the press jaw or press collar specified for the fitted pipe diameter.

Always read and understand all warnings and instructions supplied with press tools before use.

7.1 ACO203BT COMFORT LINE PRESSING TOOL

The ACO203BT (battery powered) pressing unit is lightweight and ergonomically designed for safe use and ease of handling. This unit, in conjunction with the associated press jaws or collars (M profile), is FM, VdS and LPCB approved for use with G-PRESS Piping systems from 22 mm to 54 mm in diameter. The unit’s long-life lithium-ion batteries can typically complete up to 160 press cycles before requiring battery recharge.

Features include:

- Automatic pressing cycle
- IP20 protection
- Carrying case
- Electronic monitoring of the jaw-locking-bolt and visual error indicator for additional operational safety
- Faster press cycles and lower maintenance due to the innovative brushless motor technology
- Extended lithium-ion battery life
- Battery status indicator providing continuous monitor of battery charge level
- Illumination of press area
- Electronic logbook for detailed pressing cycle records and diagnostic functions
- BLUETOOTH wireless data functionality for tool performance analysis
- Press Collar with snap on spring force attaches itself on fitting for easy handling

TABLE 7.1: ACO203BT PRESS TOOL SPECIFICATIONS

Power Supply	Charger Plug Type	Power Consumption	Piston Force	Piston Stroke	Weight	Dimensions, mm (L x W x H)
18 V / 3.0 Ah	Type F	450 W	32 kN	40 mm	2.8 kg	387 x 75 x 111

7 PRESS TOOLS FOR G-PRESS FITTINGS

7.2 ACO403BT COMFORT LINE PRESSING TOOL

The ACO403BT pressing unit is FM and VdS approved for use with G-PRESS Piping systems in 88.9 mm pipe size. With a pressing force of 120 kN and a working stroke of 60mm, the ACO403BT pressing unit provides sufficient energy for special applications with larger pipe dimensions. The unit's long-life lithium-ion batteries can typically complete 15 to 20 press cycles before requiring battery recharge. The ergonomic handles and rotatable head with a firmly mounted adaptor-jaw facilitate use in overhead and difficult-to-access locations.

Features include:

- Automatic pressing cycle
- IP20 protection
- Carrying case
- High 120 kN press force
- Faster press cycles and lower maintenance due to the innovative brushless motor technology
- Extended lithium-ion battery life
- Energy saving mode automatically switches unit off after an extended period of inactivity
- Battery status indicator providing continuous monitor of battery charge level
- BLUETOOTH wireless data functionality for tool performance analysis
- Press Collar with snap on spring force attaches itself on fitting for easy handling

TABLE 7.2: ACO403BT PRESS TOOL SPECIFICATIONS

Power Supply	Charger Plug Type	Power Consumption	Piston Force	Piston Stroke	Weight	Dimensions, mm (L x W x H)
18 V / 3.0 Ah	Type F	450 W	120 kN	60 mm	13.0 kg	650 x 95 x 320

7 PRESS TOOLS FOR G-PRESS FITTINGS

7.3 PRESS TOOL AND ACCESSORY PART NUMBERS

TABLE 7.3: PRESS TOOLS AND ACCESSORY PART NUMBERS			
Part Number	Description	Size mm	Approval
ACO203BT*	Press Tool	22 to 54	FM/VdS/LPCB
ACO403BT	Press Tool	88.9	FM/VdS
P22-203	Press Jaw	22	FM/VdS/LPCB
P28-203	Press Jaw	28	FM/VdS/LPCB
P54-203	Snap On HP Press Collar	54	FM/VdS/LPCB
P89-403	Snap On HP Press Collar	88.9	FM/VdS
ZB203*	Press Collar Adapter	54	FM/VdS/LPCB
MARKER1554	Pipe Marker	22 to 54	—
DEBUR1554	Hand Deburr Tool	22 to 54	—
BATT203	Battery for Press Tools	22 to 88.9	—

*Use the ZB203 adapter to connect Press collar for 54 mm size application

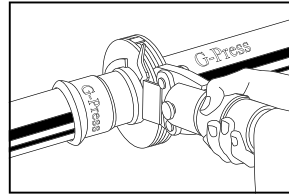
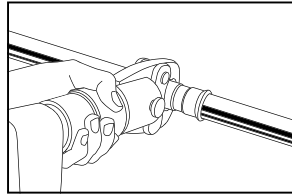

8 G-PRESS PIPE AND FITTING ASSEMBLY

8.1 PRELIMINARY REMARK

These assembly and installation instructions apply to the G-PRESS Piping system for the construction of water mist and fixed sprinkler systems only.

The G-PRESS Piping system consists of the following components:

- G-PRESS Fittings
- G-PRESS Press Pipes
- Press Tools and Accessories

8.2 TRANSPORT AND STORAGE

During the transport and storage of G-PRESS Pipes and Fittings, it is important to avoid damage and soiling.

8.3 ASSEMBLY PROCEDURE

Execute this procedure to assembly a G-PRESS Fitting onto a G-PRESS Sprinkler Pipe.

STEP 1. CUT PIPE TO SIZE

After the measurements have been taken the G-PRESS Pipe for sprinklers can be cut to size with a tube cutter or fine-toothed handsaw or electric saw, suitable for the pipe material.

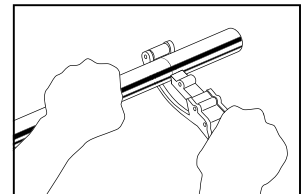

STEP 2. CHECK CUT ENDS

Check to ensure pipe ends are smooth.



STEP 3. DEBURRING CUT ENDS

The pipe ends should be carefully deburred on the inside and outside after cutting to length in order to prevent damage to the sealing ring when the pipe is inserted into the press fitting.

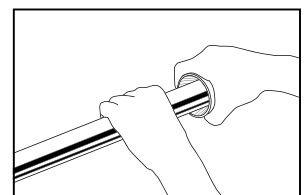

Deburring can be carried out both on the inside and outside either with a suitable hand deburrer or with an electric tube deburrer. Burr chips adhering to the pipe must be removed.

Note: Ensure pipe ends are radial and evenly rounded.

8 G-PRESS PIPE AND FITTING ASSEMBLY

STEP 4. MARK PIPE FITTING DEPTH

In order to guarantee secure and professional pressing, the required insertion depth (see Table 9) must be marked on the pipe or the press fitting featuring male ends before assembly. Reliable pressing with the corresponding tensile strengths can only be achieved by proper installation. The pressing operation behind the crimp is of crucial importance for the tensile strength. After pressing the insertion depth mark on the pipe must remain visible.

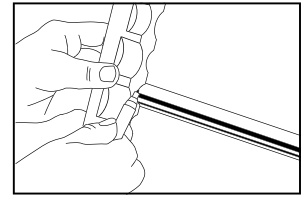

STEP 5. CHECK FITTING

Before assembly, the press fitting must be checked to ensure that it has a proper functioning sealing ring. The pipe, press fitting and sealing ring should be examined for foreign matter (e.g. dirt, burrs), which should be removed if necessary.

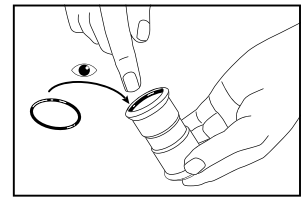

STEP 6. ASSEMBLE FITTING ONTO PIPE

Before the pressing operation the fitting or the pipe is inserted as far as the insertion depth while being rotated slightly and pressed in an axial direction at the same time. The insertion depth marking must remain visible. In the case of fittings without a stop (e.g. sleeves) the pipe must be inserted at least as far as the marked insertion depth. “Tilting” the pipe into the press fitting may result in damage to the sealing ring and is therefore not permitted. The assembly of pipe and fittings may be made more difficult due to the permitted tolerances in size. In this case the sealing ring can be treated before assembly with a lubricant, e.g. soapsuds or water.

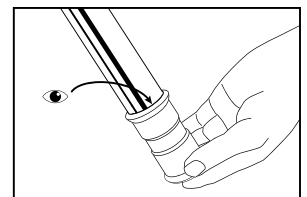

Note: Under no circumstances may oils or grease be used as lubricants.

STEP 7. PRESS CONNECTION

Select the proper press tool and jaw or collar for the intended size application. For sizes 22mm and 28mm, use the specified jaws. For sizes 54mm to 88.9mm, use the specified collars. See Table 7.3.

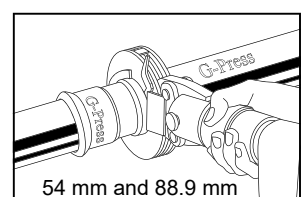
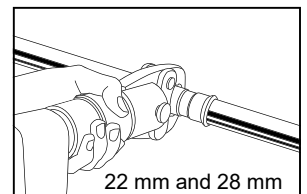

9 INSERTION DEPTH AND MINIMUM DISTANCE BETWEEN FITTINGS

For practical reasons and in order to optimize the installation time, it is standard procedure to establish a certain number of connections first before pressing the different pipe connections one after the other. Marking the distance (A) is therefore necessary in order to ensure that the pipe has not been pressed out of the fitting during the pressing procedure for the different connections. Before the final pressing operation is carried out for the different pipe connections, some of the minimum clearances must be checked, see Table 9.

TABLE 9: INSERTION DEPTH AND MINIMUM DISTANCE BETWEEN FITTINGS

Size mm	A mm	d min mm	2 x A + d min mm
22	21.0	10.0	52.0
28	23.0	10.0	56.0
54	35.0	20.0	90.0
88.9	63.0	65.0	186.0

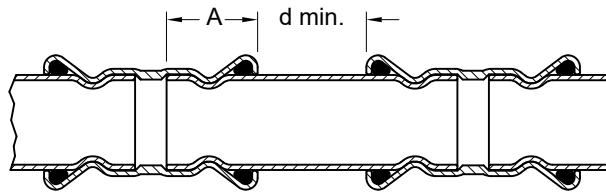

10 PRESS TOOL AND FITTING CLEARANCES

Table 10 provides important minimum distances and the space requirement for an installation in order to guarantee correct pressing. The distances refer to the general installation geometries and are shown schematically in Figures 10.1, 10.2 and 10.3.

TABLE 10: PRESS TOOL AND FITTING CLEARANCES

Size mm	Figure 10.1		Figure 10.2				Figure 10.3
	a mm	b mm	a mm	b mm	c mm	d mm	a Minimum (\geq) mm
22	65.0	25.0	80.0	31.0	35.0	150.0	40.0
28	75.0	25.0	80.0	31.0	35.0	150.0	60.0
54	120.0	85.0	120.0	85.0	85.0	290.0	70.0
88.9	250.0	170.0	250.0	170.0	210.0	460.0	90.0

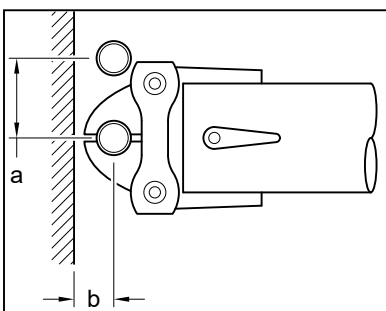

Figure 10.1

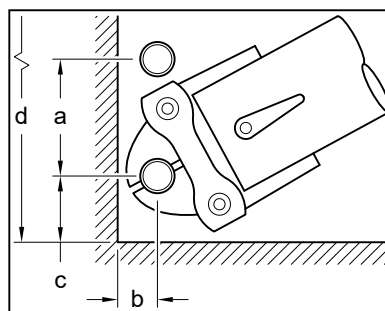

Figure 10.2

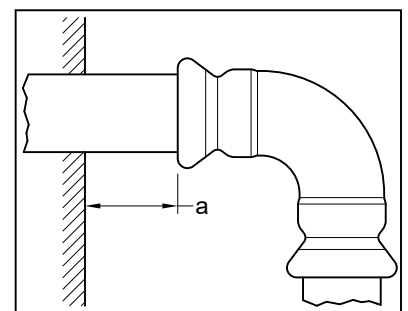

Figure 10.3

11 G-PRESS TECHNICAL DATA

11.1 WATER MIST AND FIXED SPRINKLER SYSTEMS

Water mist and fixed sprinkler systems are permanently installed fire extinguishing and fire protection systems which independently detect and report a fire and automatically start the extinguishing process. The installation of the G-PRESS Piping System in water mist and sprinkler systems is carried out in accordance with appropriate guidelines (e.g. (VdS)-CEA 4001).

When the G-PRESS Piping System is used it should also be ensured that no loads can fall on to the pipe network under normal conditions or in the case of a fire; for example ventilation ducts and cable trays must not be installed above the sprinkler pipes. If the sprinkler pipeline has to cross other structural elements such as ventilation ducts or cable trays for planning or structural reasons, the sprinkler pipeline must be secured in front of and behind these potential loads by additional components. In addition, ventilation ducts should be attached by further approved fasteners in the crossover area. The values listed in Table 11.1 apply to the fastener distances.

TABLE 11.1.1: FASTENER DISTANCES FOR SPRINKLER PIPES		
DN	Pipe Dimensions Nominal Ø x Wall Thickness mm	Fastener Distance
20	22.0 x 1.2	See valid local guidelines or NFPA 13, NFPA 750, EN12845, VdS CEA4001, EN14972-1
25	28.0 x 1.2	
50	54.0 x 1.5	
80	88.9 x 2.0	

TABLE 11.1.2: DISTANCE BETWEEN PIPELINE SUPPORTS	
Size mm	Maximum Distance m
22	2.00
28	2.25
54	3.50
88.9	4.75

11 G-PRESS TECHNICAL DATA

11.2 G-PRESS LEAK BEFORE PRESS (LBP) SEALING RING

The G-PRESS fittings up to 54 mm are supplied with an EPDM Leak Before Press (LBP) Seal Ring. Designed to ensure leakage from all unpressed connections during initial system pressurization test, the LBP seal allows the installer to immediately identify connections remaining unpressed and to take corrective action.

After pressing all fittings, the LBP seals are compressed resulting in a 100% leak-free connections for the lifetime of the piping system, preventing subsequent water damage otherwise caused by incorrectly installed fittings.

TABLE 11.2.1: G-PRESS LBP SEAL RING OPERATING PRESSURE, VDS APPROVED

DN	Nominal Ø mm	Wet and Dry System Operating Pressure bar
20	22.0	16.0
25	28.0	
50	54.0	

TABLE 11.2.2: LEAK-BEFORE-PRESS SEAL RING SPECIFICATIONS

Material	Colour	Material Code	Coating	Min./Max. Temperature C°	Max. Short-term Operating Temperature C°	Max. Operating Pressure bar
EPDM	Black	EP 1/15	Silicone-free	-34/+110	120	16.0



11 G-PRESS TECHNICAL DATA

11.3 G-PRESS STAINLESS STEEL WATER MIST AND SPRINKLER PIPE

TABLE 11.3.1: G-PRESS PIPE DIMENSIONS			
DN	Nominal Ø mm	Wall Thickness mm	Wall Thickness Tol. mm
20	22.0	1.2	± 0.10
25	28.0	1.2	
50	54.0	1.5	
80	88.9	2.0	± 0.15

TABLE 11.3.2: G-PRESS PIPE SPECIFICATIONS STAINLESS STEEL 1.4401	
Material	X5CrNiMo 17 12 2 W.No. 1.4401 to DIN-EN 10088
Type of Pipe	Arc Welded Under a Protective Atmosphere
Welding Deterioration Reduction	Not Disruptive EDDY CURRENT According to S.P.E. 1925
Weld Slag Removal	Inside and Outside
Tolerances	According to EN10217-7 D3/T3
Finishing	Annealed Under a Protective Atmosphere (W2R)
Surface Finish	Matt Silver
Marking	Continuous
Heat Expansion Coefficient	0.0166 mm/m with $\Delta t = 1^\circ K$
Yield Strength	> 205 N/mm ²
Minimum Bend Radius	3.5 x Outer Pipe Radius
Supply Mode	Pipes, Length 6 m with Protective Caps on Both Ends

TABLE 11.3.3: G-PRESS PIPE SPECIFICATIONS STAINLESS STEEL 1.4521	
Material	Material no. 1.4521 (X 2 CrMoTi18-2) According to DIN-EN 10088
Type of Pipe	Laser Welded Under a Protective Atmosphere
Welding Deterioration Reduction	Not Disruptive EDDY CURRENT According to S.P.E. 1925
Weld Slag Removal	Inside and Outside
Tolerances	According to ISO 1127 D3/T3
Finishing	Annealed Under a Protective Atmosphere (W2R)
Surface Finish	Matt Silver
Marking	Continuous
Heat Expansion Coefficient	0.0105 mm/m with $\Delta t = 1^\circ K$
Yield Strength	> 280 N/mm ²
Supply Mode	Pipes, Length 6 m with Protective Caps on Both Ends

12 CORROSION

There are different kinds of corrosion: chemical corrosion, electrochemical corrosion, internal and external local corrosion, stray current corrosion, etc. In general, all these kinds of corrosion have very particular chemical or mechanical causes. The following sections provide some simple hints that will help to prevent occurrence of these problems.

12.1 INTERNAL CORROSION

G-PRESS stainless steel pipes and G-PRESS stainless steel press fittings are completely passive when in contact with potable water and therefore not at risk from corrosion. Potable water is considered as water with properties conforming to current regulations on physical chemical tolerances. The pipes and fittings also react in a safe and problem-free manner regarding the water's chlorine content if 1.34 mg/l is added for disinfecting purposes. The G-PRESS System can also be used for all water treatment plants for domestic purposes (e.g. for water hardeners). It is corrosion resistant against glycol-containing, demineralized or distilled water. Hygiene problems regarding heavy metal contamination do not occur when using G-PRESS. Point or crack corrosion can only occur when the maximum values for the chloride content in water, as defined in the applicable regulations, are significantly exceeded.

12.2 ELECTROCHEMICAL CORROSION

For electrochemical corrosion to take place, the following conditions would have to be present:

- An electrochemical potential difference between both parts
- The presence of a conductive fluid (electrolyte), such as water
- The presence of oxygen, O₂

One should differentiate between heating installations and water supply installations. There are no significant amounts of oxygen in heating installations, when they are properly installed and operated and there will thus be very little corrosion. That is why there is very little contact corrosion with stainless steel when compared to the other metals. In potable water installations however, the oxygen content is very high, near the saturation level. It is of primary importance that the G-PRESS System components are only installed downstream of other, metallurgically inferior (less noble), components that are possibly present in these kind of installations. For example, it is possible to install branches with G-PRESS stainless steel pipes from a pipe system consisting of galvanized steel pipes. Conversely, a connection piece of non-ferrous metal or synthetics can be used (see DIN 1988). Another important factor is the ratio between the surface of the noble metal and that of the less noble metal. The higher this ratio, the greater the corrosion rate may be. It is therefore recommended to avoid using extensions or connection pieces of galvanized steel as far as possible and instead to use fittings from stainless steel or brass.

12 CORROSION

12.3 STRAY CURRENTS

Corrosion by stray currents rarely occurs in practice and it is immediately recognizable as it starts on the outside of the pipe with a cone-shaped crater to the inside. Stray current corrosion requires a direct current that turns the metal into an anode. The current in reality that, despite isolation measures, penetrates into the earth and goes on into other neighboring metal structures, such as a water supply installation, runs through a particular stretch of the system before it returns to earth again. In order to penetrate into the piping system, the earth current must have an entry point where the normal protective cover of the pipe or connection is damaged or missing. For this reason, metal pipelines must be earthed (see EU Regulations). Research over decades has shown that problems by stray currents only occur sporadically and do not depend on the type of metal.

12.4 EXTERNAL CORROSION

External corrosion of the G-PRESS System components can only occur when wet potable water pipes come into contact with mortar, droplets or covers that contain or create chlorides. Ensure that the outer isolation layer of the pipes and fittings is continuous and that sufficient corrosion-protective isolation tape is applied if necessary.

13 GENERAL INSTRUCTIONS FOR USE

13.1 FLUSHING THE SYSTEM

After completion of the installation work the entire sprinkler system has to be thoroughly rinsed through with filtered (drinking) water. Flushing of the system is necessary in order to guarantee that it is working correctly and to prevent contamination within the system. After the system has been rinsed through it has to be drained off. The water mist or sprinkler heads then have to be attached after the removal of all the materials required for flushing the network.

13.2 FILLING AND BLEEDING WET PIPE SYSTEMS

After flushing of the pipe network has been carried out, wet pipe systems should be filled with filtered drinking water and completely bled.

13.3 PRESSURE TESTING

The pipelines belonging to the water mist or sprinkler system shall be subjected to a pressure test according to valid guidelines, for example EN 12845, VdS CEA4001, NFPA750, NFPA13 or EN14972-1. During the test a test pressure (measured at the alarm valves) / test procedure must be maintained. This pressure test is a check of both the strength and tightness of the system.

14 FLOW LOSS

Every fluid that flows through a piping system experiences continuous and local flow resistances that are apparent from the pressure drop in the system. There is a difference between the continuous and the local pressure drop. The continuous pressure drop is mainly caused by the flow resistance in straight pipe sections which in turn essentially results from the friction between the fluid and the pipe wall. Local pressure drops, on the contrary, are those flow resistances that are caused by turbulence, for instance where there is a change of internal pipe diameter, a pipe branch, in an elbow, etc.

14.1 CONTINUOUS PRESSURE DROP

To calculate the total pressure drop resulting from the flow of fluids in a straight section of the piping system, first determine the pressure drop over a unit of length and then multiply the total length with this value. This value can be determined analytically using the Hazen-Williams formula:

$$p = \frac{6,05 \times 10^5}{C^{1,85} \times d^{4,87}} \times Q^{1,85}$$

p = pressure loss in the pipe (bar/meter)

Q = flow through the pipe (l/min)

d = mean internal diameter of the pipe (mm)

C = 140 (constant for type and condition of the pipe)

14.2 LOCAL PRESSURE DROP

Local pressure drop is, as mentioned in the introduction of this section, the resistance to flow that result from changes in the flow direction and cross-sectional area, flow splitting over several channels, etc. There are in general two possibilities to calculate these flow resistances: the direct analytical method and equivalent lengths method.

14 FLOW LOSS

14.2.1 DIRECT ANALYTICAL METHOD

The local pressure drop can be calculated with the following mathematical equation:

$$\Delta P_L = \sum \zeta \times v^2 \times \gamma / 2g \text{ [bar]}$$

v = flow velocity of the fluid (m/s)

g = gravitational acceleration (m/s²) (g = 10⁻⁵)

γ = specific gravity of the fluid (kg/m³)







ζ = local flow resistance coefficient

Table 14.2 provides the ζ values for every type of fitting. The given values are calculated for a water velocity of 0.7 m/s. We can assume that ζ is velocity independent for those velocities that occur in domestic installations or in other normal applications; this is supported by the fact that the change of ζ as a function of the Reynolds number in these velocity ranges is only minimal. Once the ζ value is known, one can read off directly the corresponding local pressure drop.

14.2.2 EQUIVALENT LENGTH METHOD

This is a calculation method that solves the calculation problem as a function of a particular local resistance and gives the equivalent length of a straight piece of pipe with the same diameter that would have the same pressure drop. In order to use this method of calculation all length-equivalent values for each fitting type in Table 14.2 are to be added to the actual length of the supply network. The total calculation of the equivalent length is multiplied by the unit pressure drop (R). This will show the overall resistance in the circuit. This method is not as accurate as the direct method but has the advantage that the calculation can be carried out faster.

TABLE 14.2: LOCAL PRESSURE DROP DIRECT ANALYTICAL METHOD (ζ) AND EQUIVALENT LENGTH METHOD (M) DATA

DN	Size mm														
		ζ	m	ζ	m	ζ	m	ζ	m	ζ	m	ζ	m	ζ	m
20	22	0.44	0.35	0.38	0.30	0.15	0.12	1.05	0.84	0.11	0.08	0.73	0.59	1.29	1.04
25	28	0.35	0.38	0.28	0.32	0.13	0.28	0.93	1.01	0.05	0.06	0.65	0.72	0.02	0.92
50	54	0.30	0.79	0.19	0.49	0.09	0.24	1.15	3.06	0.06	0.14	0.36	1.43	—	—
80	88.9	0.24	1.22	0.13	0.66	0.07	0.36	1.06	5.38	0.04	0.20	0.27	2.10	—	—

15 WARRANTY G-PRESS

Content of the guarantee

Tyco Fire Protection Products will compensate the direct damage as a result of culpable manufacturing defects (if diagnosed by Tyco Fire Protection Products) in the G-PRESS fittings and G-PRESS pipes; in this case Tyco Fire Protection Products provides a replacement delivery free of charge for all fittings and/or tubes to repair the damage and/or Tyco Fire Protection Products compensates the recovery expenses such as the necessary cost for removal and installation, including the costs for restoring the building in the original condition and/or other direct consequential damage, sum up to maximum of €1.000.000,- for G-PRESS fittings and pipes in stainless steel.

Indirect damage, for example (but not limited to) as a result of business or production standstill, will not be compensated.

Damage as a result of wrong assembly or improper use of G-PRESS fittings will not be compensated. The Tyco Fire Protection Products terms of guarantee apply to G-PRESS stainless steel fittings and pipes for a period of 10 years after delivery date.

For products, that have been replaced according the terms of guarantee, the period of guarantee is the same as the original supplied products. This means that for the replacement products the guarantee period starts at the delivery date of the original supplied products.